



US00783453B2

(12) **United States Patent**
Hunt et al.

(10) **Patent No.:** **US 7,834,553 B2**
(45) **Date of Patent:** **Nov. 16, 2010**

(54) **SYSTEM AND APPARATUS FOR CATHODOLUMINESCENT LIGHTING**

5,552,659 A 9/1996 Macaulay et al.
5,656,887 A 8/1997 Voshell et al.
5,965,977 A 10/1999 Makishima
5,986,399 A 11/1999 Van Veen et al.
6,081,246 A 6/2000 Cathey et al.
6,268,691 B1 7/2001 Takemura et al.

(75) Inventors: **Charles E. Hunt**, Davis, CA (US);
Regan Andrew Zane, Superior, CO (US);
Richard N. Herring, Longmont, CO (US)

(73) Assignee: **Vu1 Corporation**, Seattle, WA (US)

(*) Notice: Subject to any disclaimer, the term of this patent is extended or adjusted under 35 U.S.C. 154(b) by 209 days.

(Continued)

FOREIGN PATENT DOCUMENTS

EP 0035828 A 9/1981

(21) Appl. No.: **11/969,840**

(22) Filed: **Jan. 4, 2008**

(Continued)

(65) **Prior Publication Data**

US 2008/0185970 A1 Aug. 7, 2008

OTHER PUBLICATIONS

International Search Report and Written Opinion issued in related PCT Patent Application PCT/US2009/056684, dated Dec. 30, 2009, 14 pages.

Related U.S. Application Data

(60) Provisional application No. 60/888,187, filed on Feb. 5, 2007.

(Continued)

(51) **Int. Cl.**

H05B 39/00 (2006.01)

H01J 61/52 (2006.01)

Primary Examiner—Thuy Vinh Tran

(74) *Attorney, Agent, or Firm*—Lathrop & Gage LLP

(52) **U.S. Cl.** **315/101; 315/105; 315/116**

(58) **Field of Classification Search** 315/1, 315/3, 51, 57, 94, 101, 105, 112, 115, 116, 315/246, 247, 276, 279, 283, 287, 291, 307
See application file for complete search history.

(57) **ABSTRACT**

A cathodoluminescent lighting system has a light emitting device having an envelope with a transparent face, a cathode for emitting electrons, an anode with a phosphor layer and a conductor layer. The phosphor layer emits light through the transparent face of the envelope. The system also has a power supply for providing at least five thousand volts of power to the light emitting device, and the electrons transiting from cathode to anode are essentially unfocused. Additional embodiments responsive to triac-type dimmers with intensity and color-changes in response to dimmer control. A power-factor-corrected embodiment is also disclosed.

(56) **References Cited**

U.S. PATENT DOCUMENTS

2,967,963 A 1/1961 Ballard et al.
4,129,801 A 12/1978 Soeno et al.
4,352,043 A * 9/1982 Rigden 315/1
4,388,551 A 6/1983 Ray
4,506,191 A 3/1985 Takenobu
4,660,076 A * 4/1987 Knapp et al. 348/382
4,818,914 A * 4/1989 Brodie 315/169.3

10 Claims, 7 Drawing Sheets

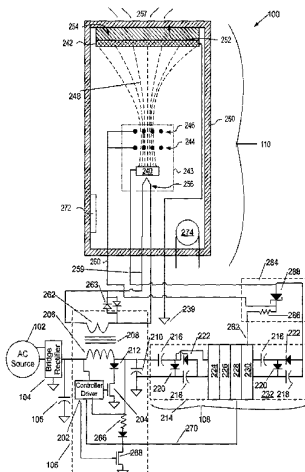

U.S. PATENT DOCUMENTS

6,354,898 B2 3/2002 Kim
6,354,989 B1 3/2002 Nudeshima
6,404,136 B1 6/2002 Murray et al.
6,504,311 B1 1/2003 Kumar et al.
6,614,149 B2 9/2003 Kastalsky et al.
2005/0156506 A1 7/2005 Chung et al.
2006/0132048 A1* 6/2006 Popovich 315/160

FOREIGN PATENT DOCUMENTS

EP 0599202 A 6/1994
GB 2070849 A 9/1981
GB 2097181 A 10/1982
WO 2006066111 A 6/2006

WO 2008098008 A1 8/2008

OTHER PUBLICATIONS

International Search Report and Written Opinion issued in related PCT Patent Application Serial No. PCT/US2008/053094, 16 pages, Jun. 6, 2008.

International Search Report and Written Opinion issued in related PCT Patent Application Serial No. PCT/US2008/053100, 17 pages, Aug. 4, 2008.

International Search Report and Written Opinion issued in related PCT Patent Application Serial No. PCT/US2005/45713, 12 pages, Jun. 12, 2008.

Office Action issued in related U.S. Appl. No. 11/684,303, 15 pages, Jun. 11, 2008.

* cited by examiner

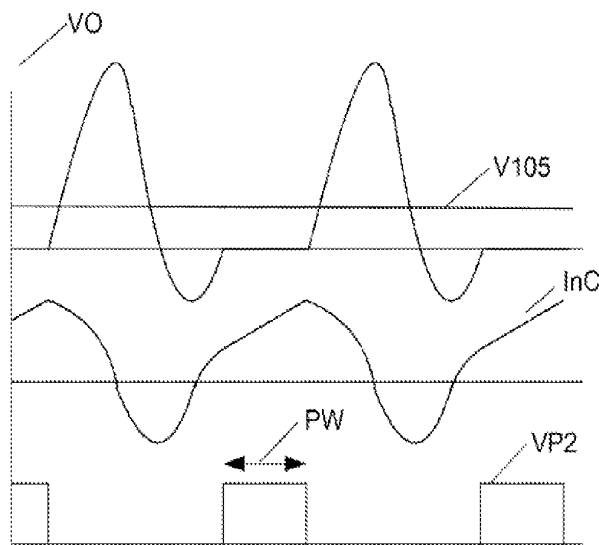
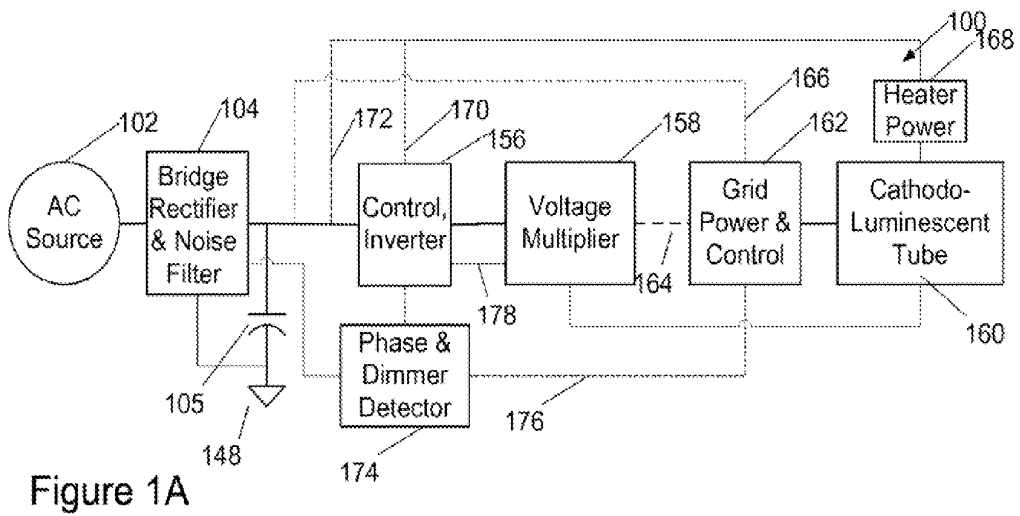
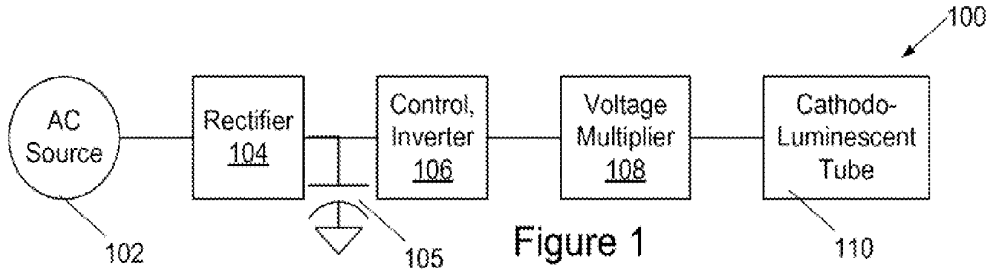

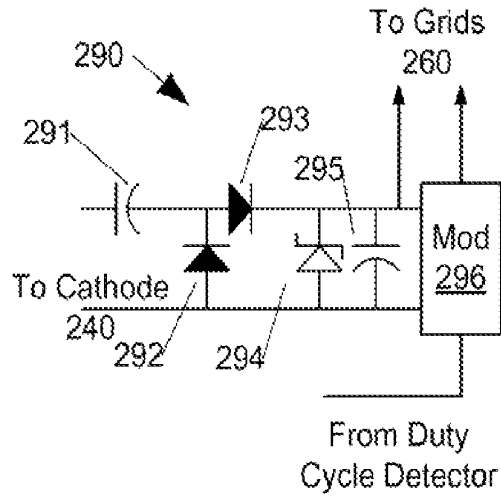

Figure 2A

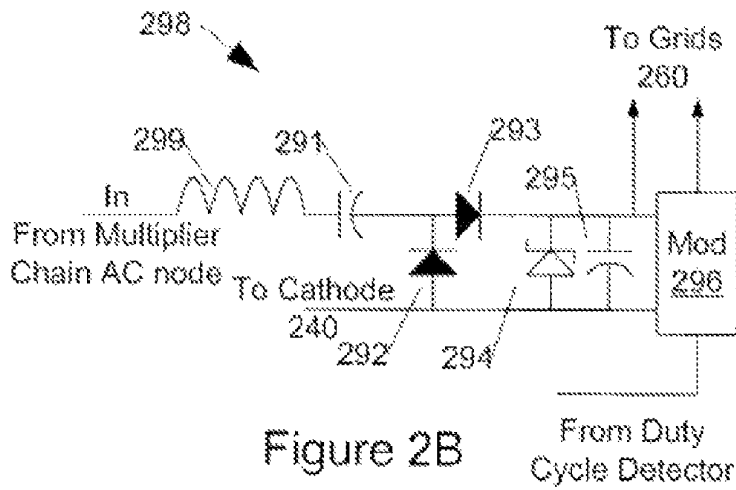
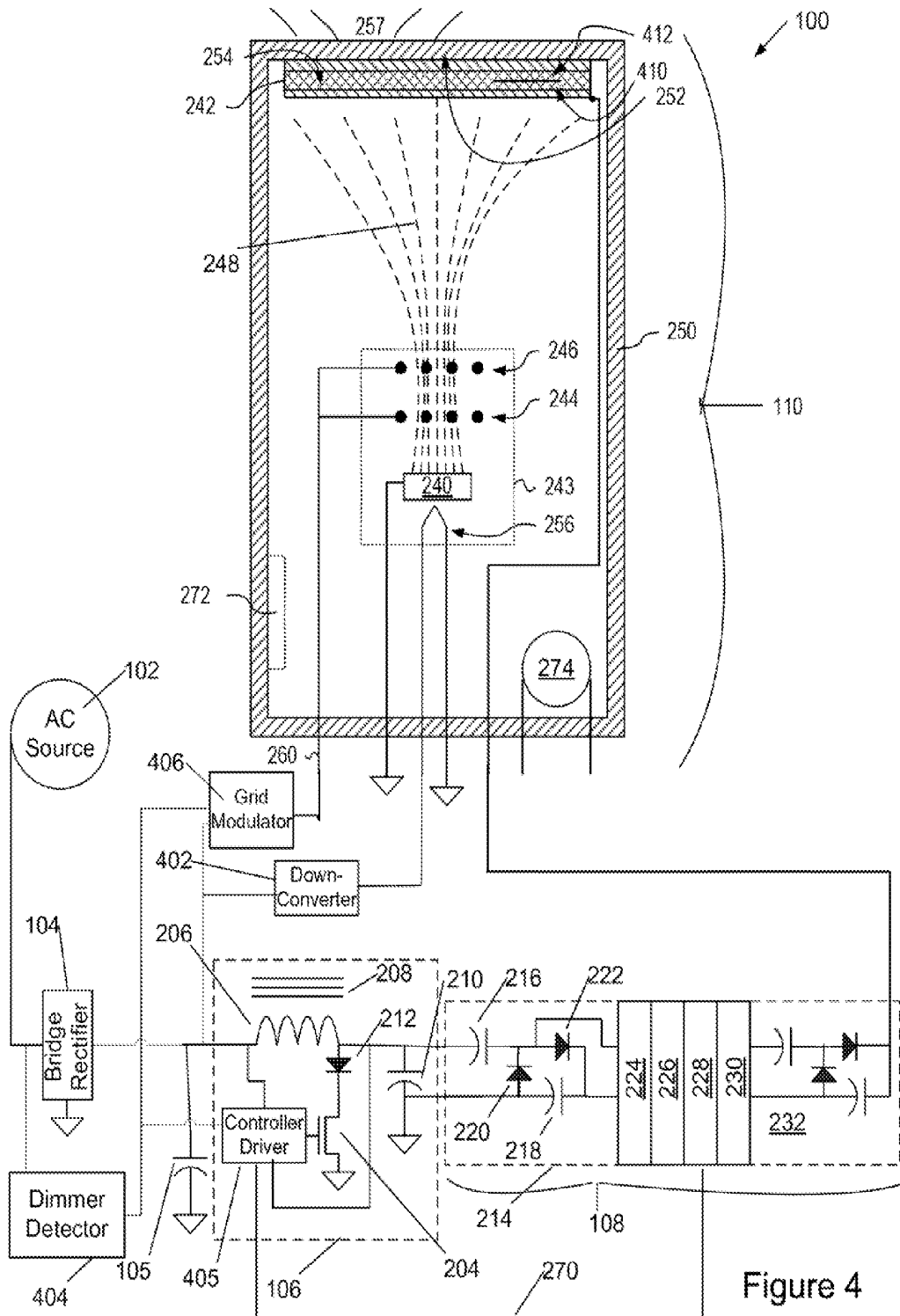
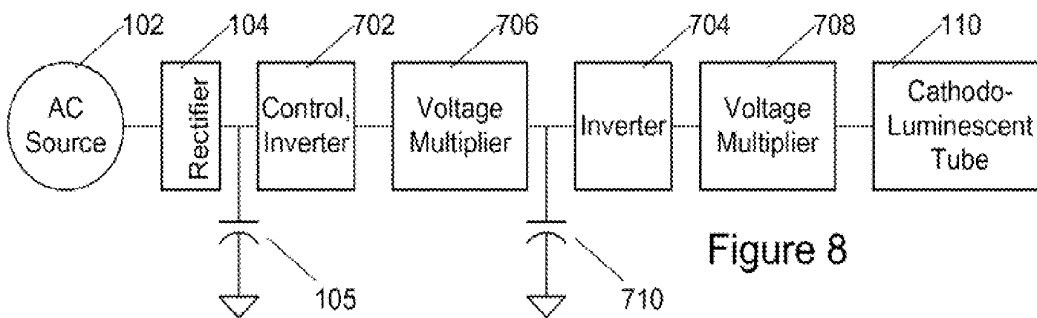
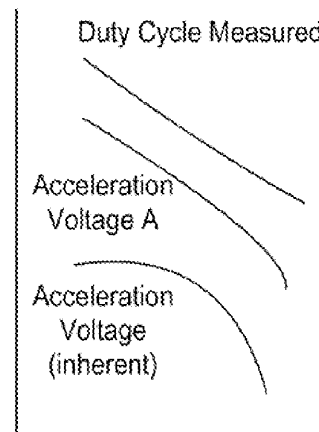
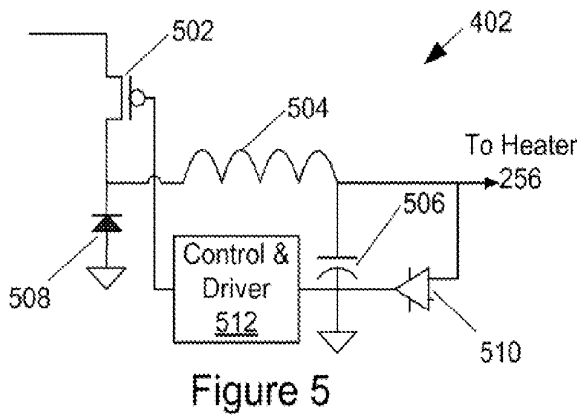
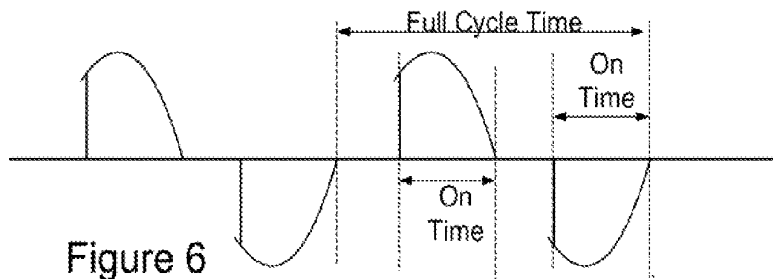

Figure 2B





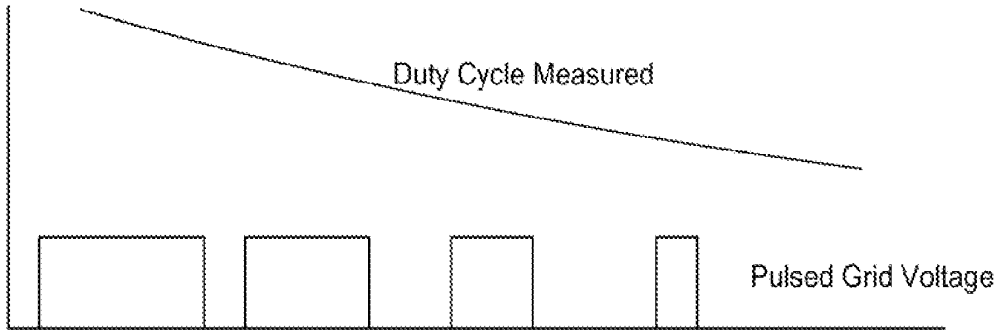

Figure 7A

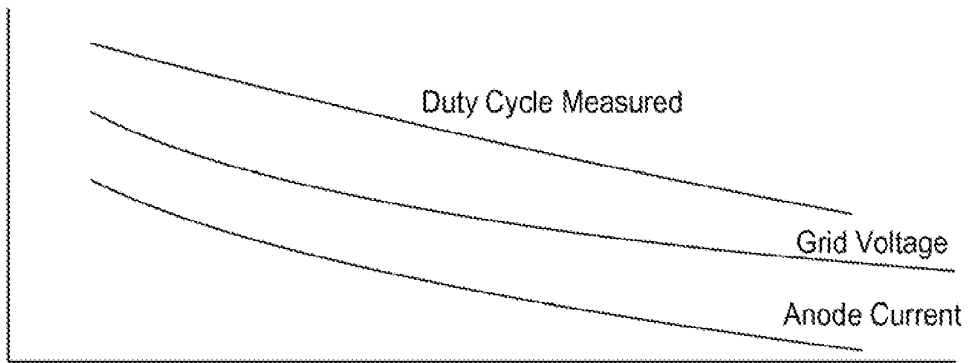

Figure 7

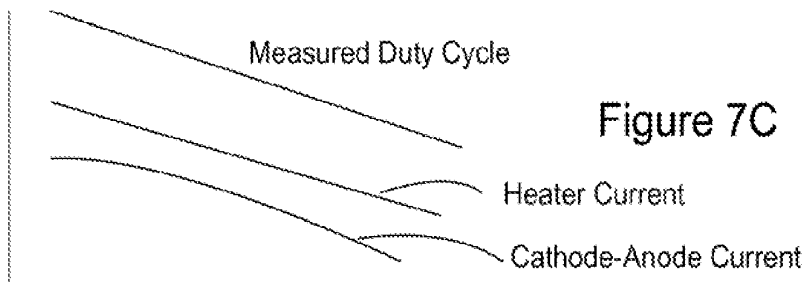

Figure 7C

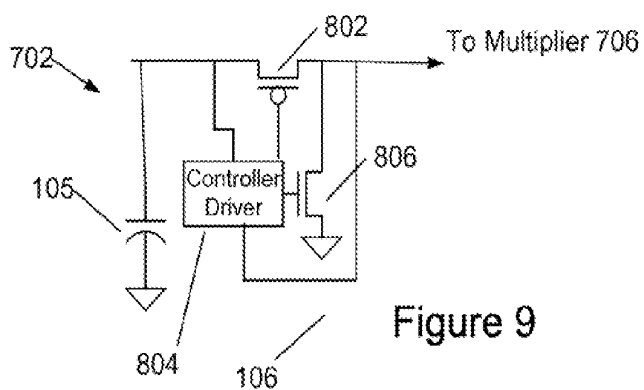

Figure 9

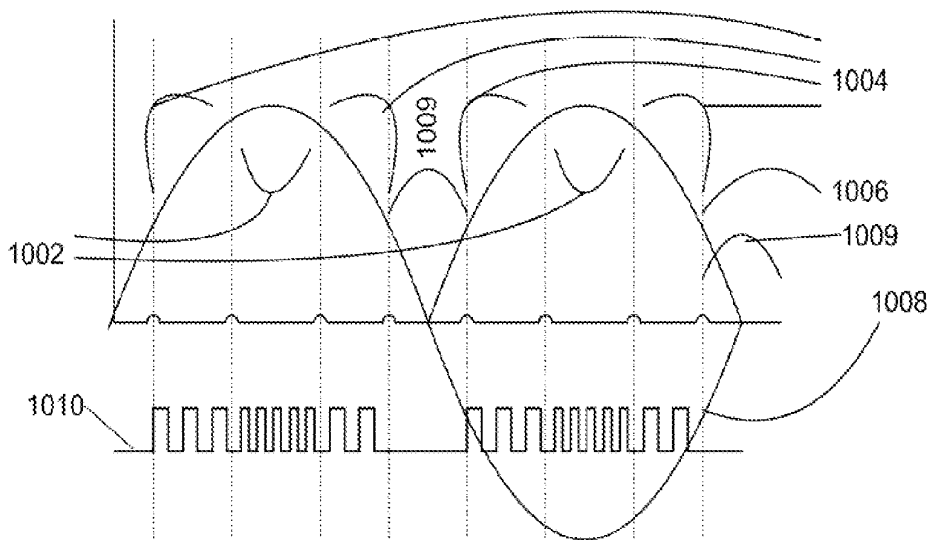

Figure 10

SYSTEM AND APPARATUS FOR CATHODOLUMINESCENT LIGHTING

RELATED APPLICATIONS

This application claims priority to U.S. Provisional Patent Application Ser. No. 60/888,187, filed Feb. 5, 2007, the disclosure of which is incorporated herein by reference. It is related to the material of copending, cofiled U.S. patent application Ser. No. 11/969,831, filed Jan. 4, 2008, entitled Cathodoluminescent Phosphor Lamp.

FIELD OF THE INVENTION

The present document describes a lighting device embodying a defocused cathode-ray device and driving circuitry. Embodiments have enhanced power factor and are compatible with conventional triac and other dimmers.

BACKGROUND OF THE INVENTION

Typically, lamps used for general lighting utilize a tungsten filament that is heated to generate light. This process, however, is generally inefficient because a significant amount of energy is lost to the environment in the form of extraneous heat and non-visible, infrared and ultraviolet, radiation. Other alternatives for general lighting include fluorescent lamps and light emitting diodes. While more efficient than incandescent lamps having tungsten filaments, fluorescent lamps tend not to have pleasing spectral characteristics, and light emitting diodes tend to be expensive.

It has been known for at least a century that electrons accelerated by high voltage in vacuum, otherwise known as cathode rays, can cause compounds known as phosphors to emit light when they strike those compounds. Much cathode ray tube (CRT) effort over the last century has been aimed towards apparatus using tightly focused, deflectable, electron beams for use in television, radar, sonar, computer, oscilloscope, and other information displays; these devices are hereinafter referenced as data display CRTs. CRTs have not generally been used for general lighting.

Data display CRTs typically operate with deflection circuitry for steering their electron beams and have such tightly focused electron beams that operation without deflection may "burn" their phosphor coating causing permanent damage. Such CRTs often, but not always, are operated by high voltage power supplies linked to their deflection circuitry.

Voltage multipliers driven by inverters have been used to provide the high voltage required to accelerate electrons in data display CRTs. For example, U.S. Pat. No. 5,331,255 describes a DC-to-DC converter having an inverter operating at about 1 MHz driving a Cockroft-Walton voltage multiplier to produce high voltage for driving a small data display CRT.

Many homes, businesses, and appliances have been wired with triac-type and similar dimmers. These dimmers block a user-adjustable portion of an alternating current waveform. Triac dimmers typically work well with incandescent lighting and other resistive loads, reducing light intensity or heat output by reducing an on-phase of each AC cycle, but typically do not work well with electronic loads such as compact fluorescent lamps.

Electronic loads such as many compact fluorescent lamps also tend to draw current as spikes almost exclusively at voltage peaks of the incoming AC waveform. These current spikes cause these loads to have a poor "power factor", and can cause inefficiencies in a power system.

SUMMARY OF THE INVENTION

A cathodoluminescent lighting system has a light emitting device having an envelope with a transparent face, a cathode for emitting electrons, an anode with a phosphor layer and a conductor layer. The phosphor layer emits light through the transparent face of the envelope. The system also has a power supply for providing at least two thousand volts between anode and cathode of the light emitting device, and the electrons transiting from cathode to anode are essentially unfocused.

BRIEF DESCRIPTION OF THE FIGURES

FIG. 1 is a block diagram of a lighting system embodying a cathodoluminescent lighting device.

FIG. 1A is a block diagram of a lighting system embodying a cathodoluminescent lighting device with power factor correction and dimmer controllability.

FIG. 2 is an approximate schematic diagram of a lighting system embodying a cathodoluminescent lighting device with thermionic cathode and inverter having an inductor with grounded anode.

FIG. 2A is a diagram of an alternate embodiment of the grid power & control such as may be used with the embodiment of FIG. 2.

FIG. 2B is a diagram of an alternate embodiment of the grid power & control such as may be used with the embodiment of FIG. 2.

FIG. 3 is an approximate waveform of the inverter of FIG. 2 in resonant mode.

FIG. 4 is an approximate schematic diagram of a lighting system embodying a cathodoluminescent lighting device with thermionic cathode and a separate downconverter, and an inverter having an inductor with grounded cathode.

FIG. 5 illustrates a buck down-converter suitable for powering a cathode heater.

FIG. 6 illustrates waveforms provided by a triac inverter.

FIG. 7 illustrates dimming of the lighting system through grid voltage control.

FIG. 7A illustrates dimming of the lighting system through grid pulsewidth control.

FIG. 7B illustrates dimming of the lighting system through acceleration voltage control.

FIG. 7C illustrates dimming of the lighting system through heater current and heater temperature control.

FIG. 8 is a block diagram of an alternative embodiment having two inverter stages.

FIG. 9 is an approximate schematic diagram of an inductorless inverter suitable for use with the embodiment of FIG. 8.

FIG. 10 illustrates power factor compensation with a pulse-width-modulated inverter having an inductor.

DETAILED DESCRIPTION OF THE EMBODIMENTS

An embodiment of a cathodoluminescent lighting system **100** (FIG. 1) is powered by an external AC power source **102**. AC power from the power source **102** is rectified by a bridge rectifier **104** into DC and filtered by a capacitor **105**. In embodiments operating from a 120-volt AC power source **102**, this resulting DC voltage is approximately 160 volts. Filtering components may also be present in the bridge rectifier **104** block to prevent undesirable emissions from being coupled back into the power source **102** and to protect cathodoluminescent lighting system **100** from spikes and surges on

AC power source 102. The resulting DC powers a controller-inverter unit 106, to provide high frequency AC that in turn feeds a voltage-multiplying rectifier 108 to provide high voltage suitable for powering a cathodoluminescent tube 110.

FIG. 1A illustrates in slightly more detail an embodiment of a lighting system 100 embodying a cathodoluminescent lighting device with power factor correction and dimmer controllability. This embodiment is powered by external AC power source 102, hereinafter mains AC. AC power from the power source 102 is rectified by a bridge rectifier 104 into DC with an internal ground 148 and filtered by capacitor 105. In embodiments operating from a 120-volt AC power source 102, this resulting DC voltage is approximately 160 volts, while in embodiments operating from a 240-volt AC power source this DC voltage is approximately 320 volts. Filtering components may also be present in the bridge rectifier 104 block to prevent undesirable emissions, such as radio frequency noise from a controller-inverter unit 156 from being coupled back into the power source 102.

The DC from rectifier 104 and capacitor 105 powers controller-inverter unit 156, to provide high frequency AC that in turn feeds a voltage-multiplying rectifier 158 to provide high voltage suitable for anode to cathode power of cathodoluminescent tube 160.

Cathodoluminescent tube 160 also requires an extraction grid bias voltage, supplied by a grid power and control unit 162. In embodiments where the cathode of cathodoluminescent tube 160 is greatly negative with respect to the internal ground 148, grid power and control unit 162 is powered by a tap 164 from voltage-multiplying rectifier 158, while in embodiments where the cathode of cathodoluminescent tube 160 is at or near internal ground 148, grid power and control unit 162 is powered by a tap 166 from capacitor 105 and rectifier 104.

In embodiments having a thermionic cathode in cathodoluminescent tube 160, cathodoluminescent tube 160 also requires heater power from a heater power supply 168. In some embodiments, including many embodiments where the cathode of cathodoluminescent tube 160 is far below internal ground 148, heater power supply 168 is inductively coupled 170 to draw power from controller-inverter unit 156. In other embodiments, heater power supply 168 is coupled 172 to draw power from capacitor 105, or coupled 173 to draw power from a node or inductor in the voltage multiplier 158.

In embodiments having power factor correction and/or dimmer controllability, a phase and dimmer detector 174 may be coupled through rectifier 104 to monitor incoming power. In embodiments having power factor correction, controller-inverter unit 156 responds to a phase detected by phase and dimmer detector 174. In many embodiments having dimmer controllability, grid power and control unit 162 responds to a detected dimmer setting signal 176 from phase and dimmer detector 174 to adjust or pulse grid voltages supplied to cathodoluminescent tube 160; alternatively in some embodiments controller-inverter unit 156 responds to detected dimmer settings by altering the AC voltage it provides to voltage multiplier 158, thereby altering anode to cathode voltages provided to cathodoluminescent tube 160.

In many embodiments, the AC voltage provided by controller-inverter unit 156 to voltage multiplier 158, or a DC voltage tapped from an early stage of voltage multiplier 158, is fed back 178 to the controller-inverter unit 156 to provide a degree of voltage regulation, thereby stabilizing anode to cathode voltages provided to the cathodoluminescent tube 160.

A particular embodiment of the cathodoluminescent lighting system 100 of FIG. 1 or FIG. 1A is illustrated FIG. 2. In

this embodiment, controller-inverter unit 106 includes a controller-driver 202 that controls a switching transistor 204. Switching transistor 204 is preferably an NMOS transistor, but may be any other suitable switching device such as an NPN or IGBT transistor as known in the art. As illustrated in FIG. 3, when transistor 204 (FIG. 2) turns on, AC voltage VO at output of the controller-inverter unit 106 and the input of the voltage multiplying rectifier 108 goes to near zero and current builds up in an inductor 206, which may be wound on a ferrite core 208; application of current to the inductor 206 through transistor 204 is known as kicking the inductor. When current reaches a maximum value determined by controller-driver 202, as determined by an effective pulsewidth PW of on-time of transistor 204, transistor 204 is turned off. The inductor 206 continues carrying current I_{nC} momentarily, causing voltage at the input of the voltage multiplying rectifier 108 to kick up well above the DC voltage V_{105} at capacitor 105. This voltage at the input of multiplying rectifier 108 appears across a capacitance that represents an input capacitance of voltage multiplying rectifier 108 in parallel with a small noise-suppression capacitor 210.

Since voltage at the input of multiplying rectifier 108 will exceed the DC voltage at capacitor 105, current I_{nC} in the inductor 206 will reverse, eventually driving voltage VO at the input of voltage multiplying rectifier 108 below the DC voltage at capacitor 105 and possibly below ground. Current in parasitic junctions of transistor 204 when voltage at the input of multiplying rectifier 108 is below ground is suppressed by a diode 212. Inductor 206 effectively forms a series-resonant circuit with the input capacitance of the multiplying rectifier 108 and noise suppression capacitor 210, and voltage at the input of multiplying rectifier 108 will resemble a portion of a damped sine wave AC waveform.

At an appropriate time in the next or a subsequent cycle of the AC waveform, preferably synchronized at an appropriate point of the waveform of voltage at the input of voltage multiplying rectifier 108 so that maximum energy is recovered from multiplying rectifier 108 and input capacitance 210, controller-driver 202 turns on VP2 switching transistor 204 again to give the inductor another kick, thereby sustaining AC at the input of the multiplying rectifier 108.

An inverter as herein described with reference to inductor 206, transistor 204, and controller-driver 202, is hereinafter a resonant-flyback inverter.

Peak current in the inductor 206, power drawn from capacitor 105, and therefore peak voltage at the input of multiplying rectifier 108 and output voltage of the multiplying rectifier are all strongly dependent upon the pulserate and pulsewidth PW of transistor 204. Operation with sparse pulses or narrow pulsewidths will reduce output voltage by reducing current in inductor 206 and resultant peak voltage at the input of voltage multiplying rectifier 108, while operation with frequent and wide pulsewidths will tend to increase output voltages.

Alternative embodiments may have other inverter designs than illustrated in FIG. 2. For example, a transformer-coupled inverter may be used, in which a secondary winding coupled to inductor 206 drives the voltage multiplying rectifier 108. In yet another embodiment, a traditional class-E stage is used to provide the AC power supplied to voltage multiplying rectifier 108.

Voltage multiplying rectifier 108 is a multistage multiplier resembling the Cockroft-Walton type. A basic stage 214 of this unit has a coupling capacitor 216, a filter capacitor 218, and two high voltage diodes 220, 222. DC output of the stage is taken at the output side of the filter capacitor 218, and DC-offset AC output is taken at the coupling capacitor 216; these outputs then feed into following stages 224, 226, 228,

230, 232. The number of stages in the multistage voltage multiplying rectifier **108** varies with the designed AC source **102** line voltage as well as desired operating conditions, including an anode **242**-a cathode **240** operating voltage, of the cathodoluminescent tube **110** and characteristics of the controller-inverter unit **106**.

Ground and an output of the final stage **232** of the voltage multiplying rectifier **108** are coupled to provide a high voltage between anode **242** of tube **110** and cathode **240** of cathodoluminescent tube **110**, such that anode **242** is positive by a voltage between two kilovolts and thirty kilovolts with respect to cathode **240**. In FIG. 2, cathode **240** is driven between two kilovolts and thirty kilovolts negative with respect to internal ground **239**, however in alternative embodiments cathode **240** is at internal ground **239** with anode **242** being driven between two kilovolts and thirty kilovolts positive with respect to ground **239**—the difference in voltage between anode **242** and cathode **240** is much more significant to tube operation than are voltages with respect to internal ground **239**.

Embodiments having cathode **240** below internal ground, with anode **242** at internal ground, are preferred because in the event of an envelope **250** fracture, cathode **240** is expected to be less likely to contact a living creature or human than is the relatively large anode **242**.

Cathode **240** forms part of an electron gun **243**, along with an extraction grid **244** and a defocusing grid **246** for emitting a broad, unfocused, beam **248** of electrons such that the voltage difference between anode **242** and cathode **240** will accelerate the electrons towards anode **242**. Anode **242** is preferably a thin, light-reflective, layer of a metal such as aluminum. Electron gun **243** and anode **242** are contained within evacuated envelope **250**, fabricated of a nonporous material such as glass and having a transparent faceplate **252**. Layered between anode **242** and faceplate **252** is at least one layer **254** of a phosphor material as known in the art of cathode-ray tube displays and chosen for desired spectral characteristics of light **257** to be emitted through faceplate **252** by operation of cathodoluminescent lighting system **100**. A thin “lacquer” layer may exist between phosphor layer **254** and anode layer **242** to prevent diffusion of anode layer **242** into phosphor layer **254**. Anode layer **242** is preferably thin enough to permit most electrons striking it to either pass through it into phosphor layer **254** or to scatter additional electrons from anode **252** into phosphor layer **254**.

In the embodiment of FIG. 2, the cathode **242** is a hot, thermionic, cathode requiring a tungsten-filament heater **256** inside the cathodoluminescent tube **110** for optimum electron emission. In embodiments having a hot cathode **240**, the heater **256** may require from half a watt to two watts of power. In an alternative embodiment, cathode **240** is a cold cathode not requiring a heater **256**. The heater **256** may in some embodiments be electrically connected **259** to the cathode **240**; in some embodiments a direct-heated cathode is used.

In embodiments having a hot or thermionic cathode **240** as illustrated, the power supply includes a heater power supply for powering the heater **256**. In the illustrated embodiment of FIG. 2, a winding **262**, magnetically coupled through core **208** to inductor **206**, is provided to provide power to heater **256**. In this embodiment, clamp diodes **263** limit peak voltage across the heater to approximately eight-tenths of a volt to prevent cathode overheating; in alternative embodiments clamp diodes **263** may be Schottky diodes to limit peak voltage across the heater to a value of less than eight-tenths of a volt. In alternative embodiments, back to back Zener diodes may be provided to limit voltage to a level higher than eight tenths of a volt, or an integrated circuit voltage or current

regulator may be provided for heater supply control. In embodiments having back-to-back Zener diodes, these diodes may have different breakdown voltages to limit voltage asymmetrically, which may provide a better match to an inverter of the type illustrated in FIG. 2, similarly embodiments having clamp diodes **263** as shown in FIG. 2 may combine a silicon with a Schottky diode to provide asymmetric clamping. In an embodiment, heater current is provided to heater **256** by an integrated regulator at a first level when the system **100** is first turned on, this current being reduced to a second level for continuing operation once the heater **256** reaches an appropriate operating temperature. In an alternative embodiment, a dump resistor **266** is provided with a suitable switch transistor **268**, this switch transistor **268** is turned ON at appropriate times during a heater **256** warm-up time when system **100** is first turned on to allow resistor **266** to absorb energy from controller-inverter unit **106** to keep current in inductor **206** high enough such that power is supplied to heater **256** through winding **262**.

In the embodiment of FIG. 2, a voltage **282** between approximately one hundred and three hundred volts positive with respect to cathode **240** is tapped from the power supply formed by bridge rectifier **104**, controller-inverter unit **106**, and voltage multiplying rectifier **108**; this voltage **282** is applied to the grid power and control **284** to provide a voltage **260** to extraction grid **244** and defocusing grid **246** of electron gun **243** of tube **110**. In an embodiment, this supply incorporates a resistor **286** and Zener diode **288** to provide voltage **260** of approximately seventy-five volts positive with respect to the cathode **240**; in alternative embodiments Zener diodes of other voltages may be used. In alternative embodiments, as illustrated in FIG. 2A, in an alternate embodiment **290** of the grid power and control **284**, a small capacitor **291** taps an AC node in the voltage multiplying rectifier **108** to power a charge pump comprising diodes **292, 293**, small filter capacitor **295** and Zener diode **294**; the charge pump coupled to cathode **240**. In some embodiments, extraction grid **244** and defocusing grid **246** are coupled directly to the filter capacitor **295**, in other embodiments including some embodiments with dimmer controllability they are coupled through grid control and modulator **296**. Grid control and modulator **296** responds to information relayed to it from the phase & dimmer detector **174** (FIG. 1A) of embodiments having dimmer control. This information may be transmitted to grid control and modulator **296** from phase & dimmer detector **174** through FM modulation of controller-inverter unit **156**, through AC signals passed inductively or through a low value blocking capacitor, or through an optical isolator (not shown).

In yet another embodiments, as illustrated in FIG. 2B, in an alternate embodiment **298** of the grid power and control **284**, a small inductor **298** is in series with capacitor **291** to tap an AC node in the voltage multiplying rectifier **108** to power a charge pump comprising diodes **292, 293**, small filter capacitor **295** and Zener diode regulators **294**. The extraction grid voltage may be derived from a modulator **296** or additional Zener diode. The charge pump is also coupled to the cathode **240** end of the voltage multiplier.

The power supply, including voltage-multiplying rectifier **108**, grid power and control **284**, and controller-inverter unit **106** is assembled using integrated circuit and surface-mount technologies as known in the art, and potted with a suitable high-voltage potting compound to prevent arcing.

In some embodiments, a voltage from a filter capacitor of the voltage-multiplying rectifier **108**, which may be, but preferably is not, the highest output voltage of the voltage-multiplying rectifier **108**, is tapped and fed back **270** through a resistive divider to controller-driver **202** of inverter **106** such

that the accelerating potential difference between anode **242** and cathode **240** is maintained at a desirable level. In an alternative embodiment, feedback control of controller-inverter unit **106** through adjustment of pulse rate and pulse-width at transistor **204** is sufficient to permit operation of the cathodoluminescent lighting system **100** on AC source voltages ranging from 110 to 250 volts and 50 to 60 hertz so as to operate on 120-volt AC as common in the United States, or on 240-volt AC as is common in many European countries.

The cathodoluminescent tube **110** may contain passive getter materials **272** or an active getter **274** as known in the art of vacuum tubes.

Another alternative embodiment of the cathodoluminescent lighting system **100**, as illustrated in FIG. **4**, has the cathode near ground and the anode positive and far from ground, with a total accelerating potential difference between anode and cathode of between two and thirty kilovolts, similar to that of the embodiment of FIG. **2**. In this embodiment, operation of the bridge rectifier **104**, and resonant inverter **106** are essentially equivalent to operation of the similar circuits of FIG. **2**, save for inversion of feedback **270**, and will not be separately described.

While some embodiments similar to that of FIG. **4** may use inductively coupled heater supply similar to that of FIG. **2**, in the embodiment illustrated in FIG. **4** a separate buck-type down-converter **402**, as illustrated in FIG. **5**, or a down-converter of another topology as are known in the switching supply art, may be used to tap power from capacitor **105** to power the heater **256**, should cathodoluminescent tube **110** be of a hot-cathode type requiring heater **256**. Buck-type down converter **402** (FIG. **5**) has a switching transistor **502**, that may be a P channel MOSFET as illustrated, a PNP bipolar transistor, or any other suitable switching transistor as known in the art. Switching transistor **502** applies brief pulses of power to an inductor **504**, which in turn draws current from a filter capacitor **506** and heater **256**. Between pulses, energy stored in inductor **504** causes continued current flow for a brief time from capacitor **506** and heater **256** through diode **508**. Heater **256** voltage may be regulated by comparison by comparator **510** to a reference (not shown) and control circuitry **512**. In some embodiments, down-converter **402** may also power the controller-driver **405** of the inverter **106**. In alternative embodiments, current is regulated by control circuitry **512** instead of or in addition to voltage being regulated; in some of these embodiments current is regulated at a first level during a warm-up period, and at a second level during normal operation. In other alternative embodiments, an integrated circuit down-converter and regulator may be used.

The embodiment of FIG. **4** is provided with a dimmer detector **404** that monitors a duty cycle of the incoming AC power source **102**. As illustrated in FIG. **6**, an output waveform of an external triac dimmer—such as is often installed in residential and commercial light-fixture wiring—provides power for only a portion or portions of each cycle. The dimmer detector **404** sums widths of “ON” times, dividing the sum by a total cycle time; it can therefore measure a duty cycle irrespective of whether the AC power source operates at 50 Hz as in Europe, or at 60 Hz as in the US, or at some other nearby frequency as may be provided by a generator. This measured duty cycle will typically be close to one hundred percent if no dimmer exists on AC supply **102**, or is representative of a dimmer control setting if a triac dimmer exists on AC supply **102**. Gate-turn-off (GTO) dimmers produce a waveform that is similar to a mirror image of the waveform illustrated in FIG. **6**; the duty cycle from those dimmers can be detected and calculated with similar circuitry.

In the embodiment of FIG. **4**, and as illustrated in FIG. **7**, a signal from the dimmer detector **404** indicative of the measured duty cycle of AC power source **102** is communicated to a grid modulator **406**. Grid modulator **406** responds to this signal by adjusting voltage **260** applied to the extraction **244** and defocusing **246** grids of cathodoluminescent tube **110**. It is expected that current between cathode **240** and anode **242** of cathodoluminescent tube **110** is dependent on voltage **260**, and, since brightness of emitted light **257** in turn depends on both voltage and current, light output of the system **100** is therefore responsive to changes in settings of the triac dimmer. In a typical embodiment, full brightness is produced when the detected duty cycle exceeds a predetermined value that need not be one hundred percent to allow for turn-on delay of a triac. In an embodiment compatible with Silicon-Controlled Rectifier (SCR) dimmers that provide a pulsating DC signal lacking, for example, the negative half-cycles of FIG. **6** at a reduced rate of 50 or 60 pulses per second, the detected duty cycle may be calculated by dividing detected on time by half of the cycle time. An embodiment with large capacitor **105** may be compatible with Triac, GTO, and SCR dimmers and both 50 and 60 hertz power systems by dividing the detected on-time by half of the cycle time when pulse rate is less than 75 hertz, and by the cycle time when pulse rate is higher than 75 hertz. Functions like these, as well as pulse-width modulation of controller-inverter unit **106** or **156**, are easy to implement on a microcontroller that may serve as a component of controller-driver **405**.

In the embodiment of FIG. **4**, the cathodoluminescent lighting system **100** responds to settings of the triac dimmer by reducing light output as duty cycle decreases.

In an alternative embodiment, the cathodoluminescent lighting system **100** operates inversely to resistive loads that may be coupled to the same triac dimmer by increasing light output as duty cycle decreases, until very low duty cycles are reached, when the inverter can not maintain adequate anode **242** to cathode **240** voltage potential difference. A lamp of this alternative, low-duty-cycle-increasing-output embodiment having a phosphor **254** optimized for a first color of emitted light **257** may be coupled in parallel with a lamp of the embodiment of FIG. **4** where low-duty-cycle decreases light **257** output and optimized for a second color of emitted light **257**; the resulting system of two light-emitting devices responds to dimmer control settings by changing a color of overall emitted light **257** as one tube becomes dimmer and another tube becomes brighter.

In yet another embodiment resembling that of FIG. **4**, or of FIG. **2** with the alternate grid bias supply and modulator of FIG. **2A**, and as illustrated in FIG. **7A**, the grid modulator **296** or **406** responds to the signal from dimmer detector **404** by altering a duty cycle of a pulse applied to the extraction **244** and defocusing **246** grids of cathodoluminescent tube **110**; the pulse switching between a level at which current between the anode **242** and cathode **240** of the cathodoluminescent light emitting device **110** is essentially off, and a level at which this current is essentially on. This pulse causes the electron beam **248** to blink on and off with a duty cycle corresponding to average light output; because of the rapid pulse rate, the blinking electron beam **248** is integrated by a persistence of phosphor layer **254** and of the human eye, the light output **256** appears not to blink but to change in brightness in response to the dimmer setting.

In yet another embodiment, and as illustrated in FIG. **7B**, the controller-driver **405** responds to the signal from dimmer detector **404** by altering an intended voltage for the anode **242** to cathode **240** acceleration voltage; controller-driver **405** causes the anode **242** to cathode **240** acceleration voltage to

approximate this intended voltage by adjusting pulsewidth of switching device **204** of the controller-inverter **106**. By doing so, the acceleration voltage may correspond to a setting of the external dimmer control in roughly linear manner, as illustrated as Acceleration Voltage A in FIG. 7B. In this embodiment, the acceleration voltage for full brightness will typically be between five and thirty kilovolts, while the acceleration voltage for a minimum brightness will be approximately two kilovolts.

In yet another embodiment, and as illustrated in FIG. 7C with reference to FIG. 4, the controller-driver **405** responds to the signal from dimmer detector **404** by adjusting a set point for heater **256** current of heater-supply down-converter **402**. When dimmer detector **404** detects a full-on duty cycle, the heater **256** current is maintained at a high level, resulting in the cathode **240** being maintained at a high temperature such that high cathode **240**-anode **242** current occurs, with bright light output. When dimmer detector **404** detects a reduced incoming duty cycle from an external triac dimmer, the dimmer detector **404** signal adjusts the heater **256** current maintained by down converter **42** to a lower level such that the cathode **240** is maintained at a lower temperature such that reduced anode **242**-cathode **240** current occurs, with dimmer light output.

In yet another embodiment, which need not have a dimmer detector, controller-driver **405** maintains approximately constant pulsewidth of switching device **204** of controller-inverter **106**. In this embodiment, assuming large capacitor **105**, acceleration voltage will vary roughly proportionately with DC voltage at capacitor **105**. While this voltage remains approximately constant while the input AC contains more than half of each half-cycle of mains AC, as the external dimmer cuts the input AC to less than half of each half-cycle, the voltage at capacitor **105** will drop with decreasing pulsewidth of the incoming AC, with result that acceleration voltage and brightness will dim along a curve such as represented by line Acceleration Voltage (Inherent) in FIG. 7B.

In yet another embodiment, cathode **240** heater **256** power supply down converter **402** responds to the signal from dimmer detector **404** by adjusting a set-point for cathode current, thereby altering temperature of the thermionic cathode **402** and altering cathode **240**-anode **242** current in the cathodoluminescent tube **110**.

The cathodoluminescent tube **110** of the embodiment of FIG. 4 resembles that of FIG. 2 and will not be separately described.

In yet another embodiment similar to that of FIG. 4, the phosphor layer **254** of the cathodoluminescent tube **110** is modified to be a bilayer, having a first layer **410** adjacent to anode **242** optimized for emitting a first color of light **256**, and a second layer **412** adjacent to faceplate **252** optimized for emitting a second color of light **256**. In this embodiment, a signal from dimmer detector **404** couples to inverter control-driver **405** such that the inverter **406** changes the anode **242** to cathode **240** potential difference. The change in potential difference is such that as the duty cycle of the controller-inverter increases, and anode **242** to cathode **240** voltage increases, electron beam **248** increases its percentage of penetration into the second phosphor **412** layer adjacent to faceplate **252**, thereby changing the color of light **256** emitted from mostly the first to mostly the second color. In this embodiment, grid modulator **406** adjusts extraction grid **244** and defocusing grid **246** voltages to maintain cathode **240** to anode **242** current such that apparent brightness of emitted light **256** is unaffected unless the duty cycle decreases below a minimum required for proper operation.

In an alternative embodiment, as illustrated in FIG. 8, controller-inverter unit **106** is replaced by two stages of inverter-control **702** and inverter **704**, and voltage multiplier-rectifier chain **108** with a first **706** and a second **708** voltage multiplier-rectifier chain. A second filter capacitor **710** is present at the output of the first voltage multiplier **706**. This embodiment permits use of fewer voltage multiplier stages than may be otherwise required, especially if no inductor is provided in inverters **702** and **704**. While functional with inverters having inductors such as inductor **206**, the embodiment of FIG. 8 is particularly suited for use with inductorless inverters such as that illustrated in FIG. 9.

Inductorless inverters such as that illustrated in FIG. 8 are particularly suitable for implementation as integrated circuits. In this embodiment, a first transistor **802** is turned on by controller/driver **804** to admit power from filter capacitor **105** to create a rising edge of a square-wave AC voltage that goes to the first **706** voltage multiplier-rectifier chain. This first transistor **802** then shuts off and a second transistor **806** drives the input to the first **706** voltage multiplier-rectifier chain low, providing a falling edge of the square-wave AC voltage. In this embodiment, first **706** voltage multiplier-rectifier chain steps up the voltage from about one hundred sixty volts at capacitor **105** to about one kilovolt at second filter capacitor **710**. The second stage inverter **704** drives second multiplier-rectifier stage **708** to produce a two kilovolt to thirty kilovolt anode to cathode potential.

With large capacitance at filter capacitor **105** (FIG. 2), current draw by the cathodoluminescent lighting system occurs mostly near peaks of incoming sine-wave AC power source **102**, the peak region **1002** in FIG. 10, with little or no power drawn at other points in the cycle of the incoming sine-wave AC power. This can produce a poor "power factor", such that large numbers of high power lighting systems of this type can cause inefficient operation of the power source as well as causing excessive radio frequency interference.

In order to compensate for this, in a power-factor corrected embodiment having an inductor-equipped controller-inverter unit **106**, as shown in FIG. 2, and used particularly either without dimming or with gate pulsing dimming, filter capacitor **105** is made small—just big enough to minimize radiation due to switching of transistor **204**, such that considerable ripple may be observed across filter capacitor **105**.

In this enhanced power-factor embodiment, during shoulder regions **1004** of the bridge rectified pulsating DC **1006**, the controller-inverter unit **106** operates with an increased switching-transistor **204** pulsewidth such that the voltage at output of inductor **206** continues to kick up high enough to provide a high-enough AC output voltage at the input of voltage multiplying rectifier **108** to ensure that appropriate power is drawn from the AC power source **102** and fed to the voltage multiplier **108**. In this embodiment, instantaneous phase, or whether the incoming AC power is at peak **1002**, shoulder **1004**, or near crossover **1009** of the incoming sine wave **1008**, is detected by instantaneous phase and dimmer detector **174** (FIG. 1A) by measuring voltage across capacitor **105** and comparing the voltage measured with a peak voltage measured during a previous cycle or half cycle.

A single embedded microcontroller is capable of determining both instantaneous phase and duty cycle provided by an external dimmer, as well as whether the incoming AC voltage is fifty or sixty cycle, one hundred fifteen or two hundred thirty volt, power and determining an appropriate instantaneous pulse width and pulse rate for the inverter. In a microcontroller embodiment, instantaneous phase and dimmer detector **174**, the controller portion of controller-driver **405** of controller-inverter **406**, and controller portions of grid modu-

lator **406** and heater power supply down converter **402** may all be implemented within a single microcontroller.

In this enhanced power-factor embodiment, the controller-inverter unit **106** operates with a reduced pulse rate in shoulder regions **1004** to reduce the total power drawn in the shoulder regions **1004** so as to approximate a sinusoidal power draw from AC supply **102**. Similarly, the controller-inverter unit **106** pulse rate may stop momentarily during zero-crossing regions **1009** of the incoming waveform. Waveform **1010** illustrates some of the pulsewidth and pulse rate changes, albeit illustrated at a much reduced rate, that occurs through a cycle of the incoming AC power. These changes in pulse width and rate throughout a cycle may be readily controlled by a microcontroller in the controller-driver **202**, **405** of controller-inverter unit **106**, **156**.

In this enhanced power-factor embodiment, feedback **270** control of controller-inverter unit **106**, and charge storage in capacitors **218** may be sufficient that anode **242** to cathode **240** voltage may remain essentially constant throughout each cycle.

In an alternative embodiment, a three-contact connector, such as a 3-way Edison base, having two AC inputs and a neutral input, is used. In this embodiment, two bridge rectifiers are incorporated into bridge rectifier and noise filter unit **104**, such that the lighting system **100** is capable of operation off of either of the two AC inputs. Dimmer detector **174**, **404** operates by determining which of the two AC inputs, or both, are active, and providing an appropriate output signal to grid power and control **162**, **406**. This alternative device is compatible with lighting fixtures of the "3-way" type, such that both AC inputs being "on" gives a first level of light output, a first of the AC inputs being "on" with a second "off" gives a second level of light output, and the second of the AC inputs being "on" with the first "off" gives a third level of light output.

While the forgoing has been particularly shown and described with reference to particular embodiments thereof, it will be understood by those skilled in the art that various other changes in the form and details may be made without departing from the spirit hereof. It is to be understood that various changes may be made in adapting the description to different embodiments without departing from the broader concepts disclosed herein and comprehended by the claims that follow.

What is claimed is:

1. An apparatus for providing power to a cathodoluminescent light emitting device, the power provided to the cathodoluminescent lighting device including power for a potential difference between an anode and a cathode, comprising:

- a rectifier for converting input AC to a DC power;
- a resonant flyback inverter for converting the DC power to internal AC comprising an inductor coupled in series with a blocking diode and a switching transistor, the

inductor, blocking diode, and transistor together coupled across the DC power, the internal AC coupled from the inductor;

circuitry for providing a potential difference between the cathode and a grid of the cathodoluminescent device; and

a voltage-multiplying rectifier for receiving the internal AC and for providing the potential difference between the cathode and the anode of the cathodoluminescent light emitting device.

2. The apparatus claim **1**, further comprising power factor correction.

3. The apparatus of claim **1** wherein the apparatus modulates light emitted by the cathodoluminescent light emitting device by adjusting at least one grid voltage in the cathodoluminescent light emitting device.

4. The apparatus of claim **3** wherein the apparatus adjusts the at least one grid voltage in the cathodoluminescent light emitting device between a current-on and a current-off level with a duty cycle determined by measurement of the duty cycle of the incoming AC power.

5. The apparatus of claim **3** wherein the apparatus enables operation at input AC supply voltages from 110 to 250 volts for compatibility with European and United States power distribution systems.

6. The apparatus for providing power of claim **1** wherein the apparatus further comprises a secondary winding magnetically coupled to an inductor selected from the group consisting of the inductor of the resonant flyback inverter and an inductor of the circuitry for providing the potential difference between the cathode and the grid, the secondary winding coupled to power a heater of the cathode of the cathodoluminescent light emitting device.

7. The apparatus of claim **1** further comprising circuitry for dimming the cathodoluminescent light emitting device according to a duty cycle of the input AC.

8. The apparatus of claim **7** further comprising an apparatus for providing power to a cathode heater of the cathodoluminescent light emitting device, and wherein the circuitry for dimming the cathodoluminescent light emitting device operates by adjusting the power provided to the cathode heater.

9. The apparatus of claim **7** wherein the apparatus for dimming the cathodoluminescent device operates by pulse-width modulating a grid voltage of the cathodoluminescent device, such that when the duty cycle of the external AC supply is low, narrow pulses are applied to a grid of the cathodoluminescent device and that when the duty cycle of the external AC supply is high, wide pulses are applied to the grid of the cathodoluminescent device.

10. The apparatus of claim **7**, wherein the apparatus for dimming the cathodoluminescent device operates by adjusting a parameter selected from the group consisting of grid voltage of the cathodoluminescent device and accelerating potential of the cathodoluminescent device.

* * * * *